

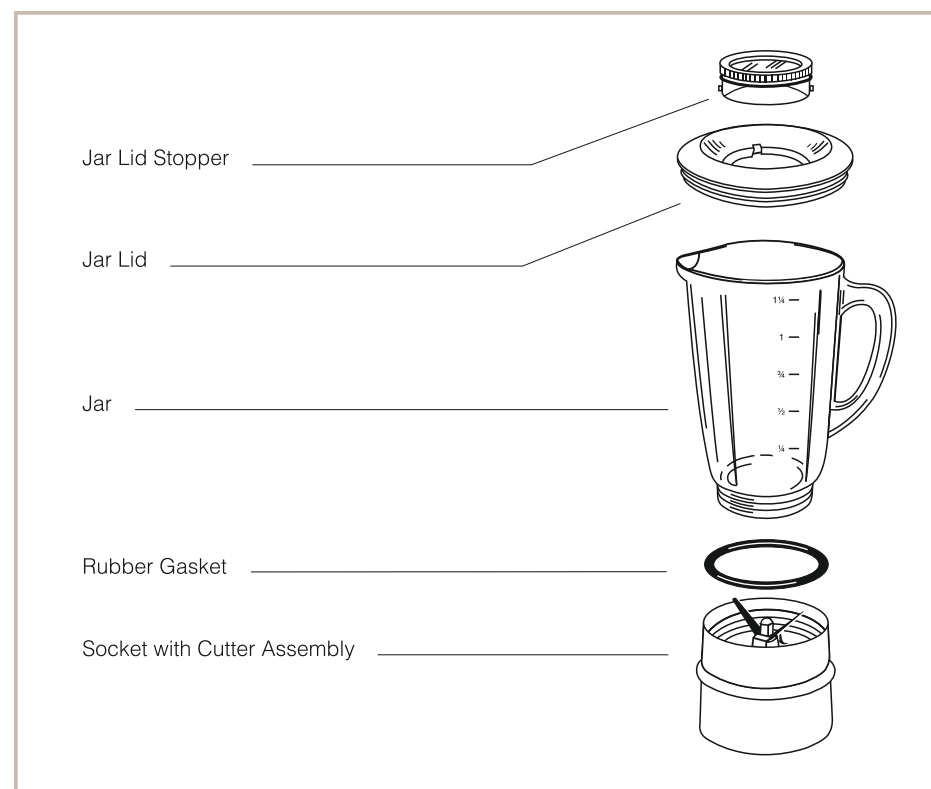

Before operating this unit, read the instructions carefully.

**IDENTIFICATION OF PARTS**



Frootmix blender attachment has been shown above in a completely disassembled position.

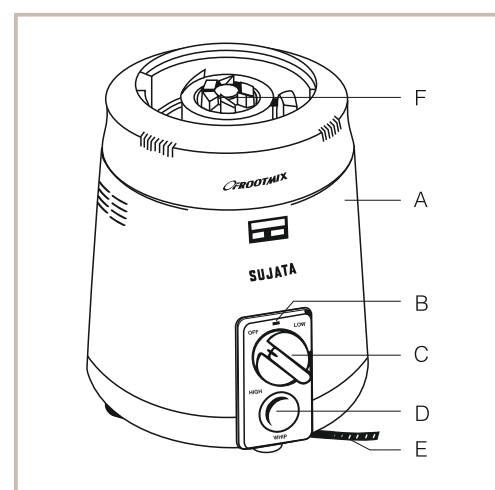

Motor Unit

- Motor Unit**  
 A. Motor Housing  
 B. Indicator Light  
 C. Speed Knob  
 D. Whip Button  
 E. Mains Cord  
 F. Driving Coupler

**USING THE BLENDER**



Place the Blender on the motor unit firmly.

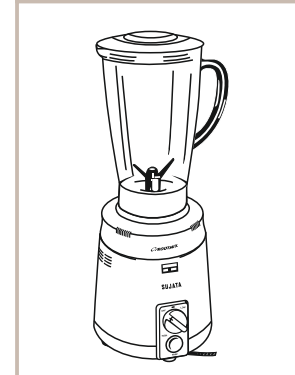

Plug into a convenient electric outlet. Put ingredients into jar and cover it. Select 'HIGH' speed by turning the **Speed Knob**. However a speed other than the one suggested above can be used to suit the recipe.

**CLEANING THE MOTOR UNIT**

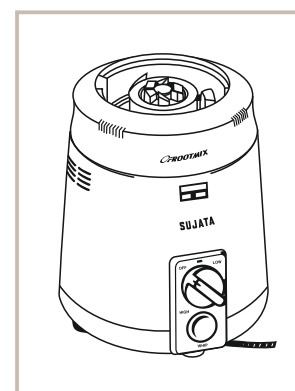

To clean the motor housing, simply wipe with a damp cloth and dry. **Never immerse motor housing in water.**

**CLEANING THE BLENDER**

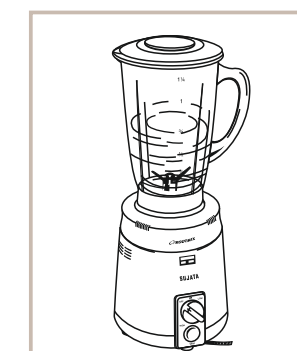

To clean the blender jar quickly and thoroughly, fill the jar one third full of luke warm water, and add a few drops of detergent or soap flakes. Switch the motor ON and run for some time. The soapy water will clean the jar. Switch off the motor and empty the blender jar.

Refill the jar with fresh water without any detergent. Restart the motor and empty the jar again after switching off.

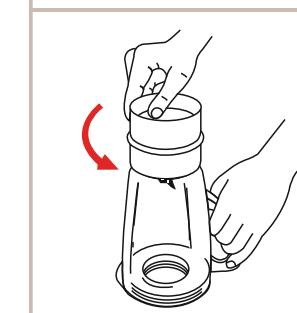

Place the blender jar upside - down and unscrew the socket anti-clockwise.

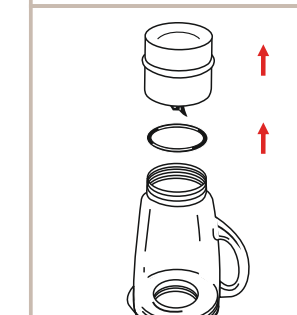

Remove the Socket (with Cutter Assembly) and then the Rubber Gasket.



Rinse well each part, and wipe off the water with a cloth and let it dry before storing.

**HOW TO CHANGE THE DRIVING GEAR\***

If proper care is taken to ensure that the **motor stops completely before mounting, removing or replacing the jar**, the Driving Gear may never get damaged. In case carelessness occurs and **Driving Gear Teeth** get worn off, the set of Teeth can be easily replaced at home. A set of **'Driving Gear Teeth and Screws'** can be purchased from the Service Centre.

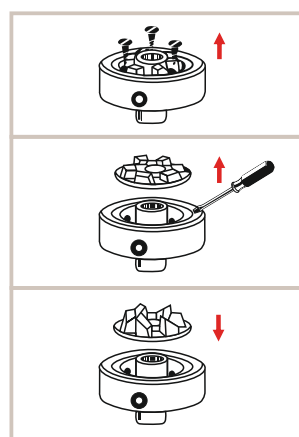

Unscrew the three screws located amidst the Teeth of Driving Gear.

Lift up the worn set of Teeth from the Driving Base by putting a screw driver in any of the two grooves provided.

Clean the top surface of the Driving Base with a dry cloth. Put a new set of **Driving Gear Teeth** and tighten with screws. Use either the old screws or the new ones (provided with the set). Screws of a different size may damage the unit.

\*The **Driving Gear Teeth** can be detached only from **Driving Coupler** made of **plastic**. In models which are provided with **Driving Coupler** made of **metal**, there is no provision of detaching the **Driving Gear Teeth** because the metallic teeth hardly get worn off.

**PRECAUTIONS**

- Always use 3 pin plug for connecting the electrical supply.
- After using, the switch must be turned off and electric supply disconnected by gripping the plug and pulling it from the electric outlet (never pulling the cord).
- Do not let cord hang over the edges of tables or counter or touch hot surfaces.
- To protect against electrical hazards, do not immerse motor unit or cord plug in water or other liquids. Never use outdoors or on wet surfaces.
- Keep away from the moving parts. Do not insert finger, knife etc. in jar while in operation.
- Do not remove or replace any attachment or attachment cover when the motor is on.
- Do not run the motor without load.
- Switch off the motor, if it stalls or smoke emanates from the motor.
- Cover the blender (liquidiser) jar before switching the motor on else small quantity of ingredients may be hurled out against the walls by the sudden impact of the blades.
- Blades are sharp, handle carefully while cleaning.
- Keep Machine away from direct heat or sun. Never wash the parts in hot water.
- Do not run the machine unless jar is in position. Covers and lids should be firmly placed too.
- Do not run the motor for more than 90 minutes continuously.

**CARE AND MAINTENANCE**

- Before first use or after long unuse, check to see if shaft rotates smoothly.
- Always place the blender onto the motor unit properly in order to avoid vibration and mismatching of the blender gear with the driving gear of the motor unit.
- Never run the blender empty.
- Never put ice cubes. Always use crushed / shaved ice only.
- Never put very hot liquid in the blender jar. Allow cooked vegetables and hot liquids to cool down before pouring into the blender (liquidiser).
- Never fill the blender upto the top to avoid the spilling of the material.
- The air ventilation holes at the bottom of the motor unit may get blocked if the machine is used on any thin plastic sheet, cloth or paper etc. They get sucked up, blocking the ventilation holes and causing excessive heating up of the motor.
- For optimum efficiency, the machine should be operated at the specified voltage only. Wide voltage fluctuations during operation affect the quality of blending / mixing adversely.
- Avoid overloading the machine with extra heavy load. If after loading the machine and switching on the electric supply, the motor does not start or runs at a very low speed, check if the material filled is too much. If so, reduce it and proceed again.

**SPECIFICATIONS\***

Model Type & No.	: <b>SUJATA FROOTMIX</b>
Motor	: Heavy duty, universal type 900 Watts with double ball bearing.
Power Supply	: 230 to 240 Volts, AC 50 - 60 Hz.
Power Consumption	: 900 Watts on maximum load.
Rating	: 90 minutes.
Speed Control	: 3 Speed with Rotary action switch.
	: Whipper button for momentary motion.
Motor Speed	: No load speed maximum approx. 22000 R.P.M.
Protection	: Class I double insulated.
Flex Cord	: P.V.C. approx. 2.15 meters usable with 5 Amp. 3 pin plug.
Net Weight with Carton	: 4.5 Kg. approx.
Dimensions (in Cms.)	: 39 x 23 x 33
Capacity of Jar	: 1750 ml.

\* Due to continuous upgradation in quality, design and specifications can be changed at any time without notice.

**ONE YEAR WARRANTY**

**WARRANTY IS NOT VALID IF THIS PRODUCT IS USED FOR COMMERCIAL PURPOSE**



is warranted against manufacturing defects for a period of ONE YEAR from the date of purchase. Within this period any defective unit will be repaired or replaced at manufacturer's option free of cost subject to the unit being delivered to our authorised service centre at customer's cost.

The warranty does not cover damages resulting from commercial use, accident, mishandling or negligence on the part of customer or non compliance of instructions in the operating manual or if the mechanism is tampered with by the customer or any unauthorized person other than our service personnel.

The warranty card duly stamped and signed by the dealer alongwith the cash memo should be produced to the authorised service centre, otherwise the warranty will be treated as invalid. Liability for consequential damages or loss is neither accepted nor implied under the warranty.

**SUJATA** Sr. No. \_\_\_\_\_ Checked by \_\_\_\_\_

Cash Memo No. \_\_\_\_\_ Date \_\_\_\_\_

Customer's name & Address \_\_\_\_\_

Customer's telephone \_\_\_\_\_

Signature of the Dealer \_\_\_\_\_

**RUBBER STAMP OF THE DEALER**

**FROOTMIX**



\*28052\*